

LM5102 High-Voltage Half-Bridge Gate Driver With Programmable Delay

1 Features

- Drives Both a High-Side and Low-Side N-Channel MOSFET
- Independently Programmable High and Low Side Rising Edge Delay
- Bootstrap Supply Voltage Range up to 118 V dc
- Fast Turn-Off Propagation Delay (25 ns Typical)
- Drives 1000-pF Loads with 15-ns Rise and Fall Times
- Supply Rail Undervoltage Lockout
- Low Power Consumption
- Timer Can Be Terminated Midway Through Sequence

2 Applications

- Current Fed Push-Pull Power Converters
- Half and Full Bridge Power Converters
- Synchronous Buck Converters
- Two Switch Forward Power Converters
- Forward with Active Clamp Converters

3 Description

The LM5102 high-voltage gate driver is designed to drive both the high side and the low side N-Channel MOSFETs in a synchronous buck or a half bridge configuration. The floating high-side driver is capable of working with supply voltages up to 100 V. The outputs are independently controlled. The rising edge of each output can be independently delayed with a programming resistor. An integrated high voltage diode is provided to charge the high side gate drive bootstrap capacitor. A robust level shifter operates at high speed while consuming low power and providing clean level transitions from control logic to the high side gate driver. Undervoltage lockout is provided on both the low side and the high side power rails. This device is available in the standard VSSOP 10 pin and the WSON 10 pin packages.

Device Information⁽¹⁾

PART NUMBER	PACKAGE	BODY SIZE (NOM)
LM5102	VSSOP (10)	3.00 mm x 3.00 mm
	WSON (10)	4.00 mm x 4.00 mm

(1) For all available packages, see the orderable addendum at the end of the data sheet.

Simplified Block Diagram

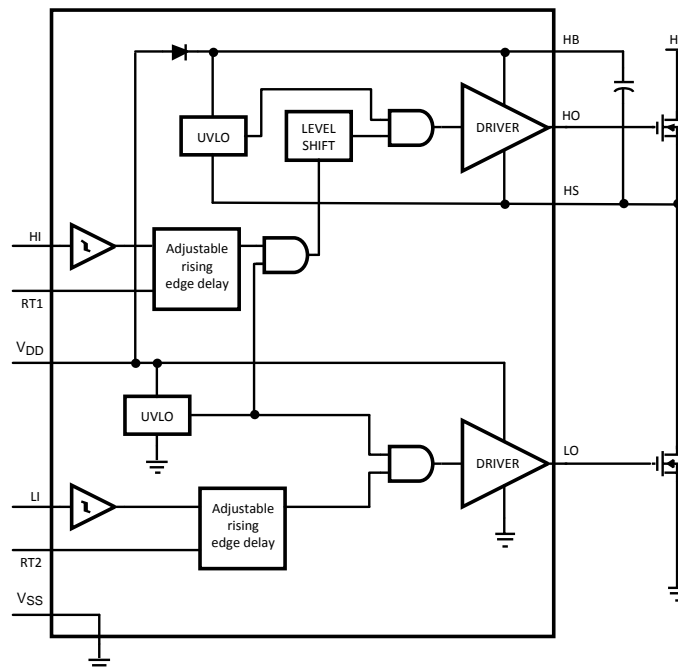

Table of Contents

1 Features	1	7.3 Feature Description.....	10
2 Applications	1	7.4 Device Functional Modes.....	10
3 Description	1	8 Application and Implementation	11
4 Revision History	2	8.1 Application Information.....	11
5 Pin Configuration and Functions	3	8.2 Typical Application	11
6 Specifications	4	9 Power Supply Recommendations	13
6.1 Absolute Maximum Ratings	4	9.1 Power Dissipation Considerations	13
6.2 ESD Ratings.....	4	10 Layout	14
6.3 Recommended Operating Conditions.....	4	10.1 Layout Guidelines	14
6.4 Thermal Information	4	10.2 Layout Example	15
6.5 Electrical Characteristics.....	5	11 Device and Documentation Support	15
6.6 Switching Characteristics	6	11.1 Trademarks	15
6.7 Typical Characteristics	7	11.2 Electrostatic Discharge Caution.....	15
7 Detailed Description	10	11.3 Glossary	15
7.1 Overview	10	12 Mechanical, Packaging, and Orderable Information	15
7.2 Functional Block Diagram	10		

4 Revision History

Changes from Revision A (March 2013) to Revision B

Page

- Added Handling Rating table, Feature Description section, Device Functional Modes, Application and Implementation section, Power Supply Recommendations section, Layout section, Device and Documentation Support section, and Mechanical, Packaging, and Orderable Information section. 1

Changes from Original (March 2013) to Revision A

Page

- Changed layout of National Data Sheet to TI format

5 Pin Configuration and Functions

10 Pin
VSSOP (DGS), WSON (DPR)
Top View

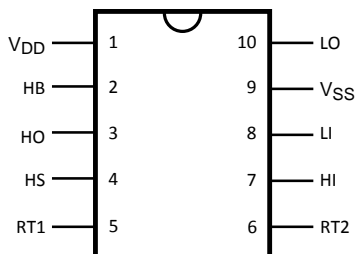

Pin Functions

PIN		TYPE ⁽¹⁾	DESCRIPTION	APPLICATION INFORMATION
NAME	WSON ⁽²⁾ , VSSOP			
HB	2	P	High-side gate driver bootstrap rail	Connect the positive terminal of bootstrap capacitor to the HB pin and connect negative terminal of bootstrap capacitor to HS. The Bootstrap capacitor should be placed as close to IC as possible.
HI	7	I	High-side driver control input	TTL compatible thresholds. Unused inputs should be tied to ground and not left open.
HO	3	O	High-side gate driver output	Connect to gate of high-side MOSFET with short low-inductance path.
HS	4	P	High-side MOSFET source connection	Connect bootstrap capacitor negative terminal and source of high side MOSFET.
LI	8	I	Low-side driver control input	TTL compatible thresholds. Unused inputs should be tied to ground and not left open.
LO	10	O	Low-side gate driver output	Connect to the gate of the low side MOSFET with a short low inductance path.
RT1	5	A	High-side output edge delay programming	Resistor from RT1 to ground programs the leading edge delay of the high side gate driver. The resistor should be placed close to the IC to minimize noise coupling from adjacent traces.
RT2	6	A	Low-side output edge delay programming	Resistor from RT2 to ground programs the leading edge delay of the low side gate driver. The resistor should be placed close to the IC to minimize noise coupling from adjacent traces.
V _{DD}	1	P	Positive gate drive supply	Locally decouple to VSS using low ESR/ESL capacitor, located as close to IC as possible.
V _{SS}	9	G	Ground return	All signals are referenced to this ground.

(1) P = Power, G = Ground, I = Input, O = Output, A = Analog

(2) For the WSON package, it is recommended that the exposed pad on the bottom of the LM5100 and LM5101 be soldered to ground plane on the PC board, and the ground plane should extend out from beneath the IC to help dissipate the heat.

6 Specifications

6.1 Absolute Maximum Ratings⁽¹⁾⁽²⁾

	MIN	MAX	UNIT
V_{DD} to V_{SS}	-0.3	18	V
V_{HB} to V_{HS}	-0.3	18	V
LI or HI Inputs to V_{SS}	-0.3	$V_{DD} + 0.3$	V
LO Output	-0.3	$V_{DD} + 0.3$	V
HO Output	$V_{HS} - 0.3$	$V_{HB} + 0.3$	V
V_{HS} to V_{SS}	-1	100	V
V_{HB} to V_{SS}		118	V
RT1 and RT2 to V_{SS}	-0.3	5	V
Junction Temperature		150	°C
Storage Temperature Range	-55	150	°C

- (1) Stresses beyond those listed under *Absolute Maximum Ratings* may cause permanent damage to the device. These are stress ratings only, which do not imply functional operation of the device at these or any other conditions beyond those indicated under *Recommended Operating Conditions*. Exposure to absolute-maximum-rated conditions for extended periods may affect device reliability.
- (2) If Military/Aerospace specified devices are required, please contact the Texas Instruments Sales Office/Distributors for availability and specifications.

6.2 ESD Ratings

	VALUE	UNIT
$V_{(ESD)}$ Electrostatic discharge Human-body model (HBM), per ANSI/ESDA/JEDEC JS-001 ⁽¹⁾	±2000	V

- (1) JEDEC document JEP155 states that 500-V HBM allows safe manufacturing with a standard ESD control process.

6.3 Recommended Operating Conditions

	MIN	MAX	UNIT
V_{DD}	9	14	V
HS	-1	100	V
HB	$V_{HS} + 8$	$V_{HS} + 14$	V
HS Slew Rate		< 50	V/ns
Junction Temperature	-40	125	°C

6.4 Thermal Information

THERMAL METRIC ⁽¹⁾	LM5102		UNIT
	DGS	DPR ⁽²⁾	
	10 PINS	10 PINS	
$R_{\theta JA}$ Junction-to-ambient thermal resistance	165.3	37.9	°C/W
$R_{\theta JC(top)}$ Junction-to-case (top) thermal resistance	58.9	38.1	
$R_{\theta JB}$ Junction-to-board thermal resistance	54.4	14.9	
Ψ_{JT} Junction-to-top characterization parameter	6.2	0.4	
Ψ_{JB} Junction-to-board characterization parameter	83.6	15.2	
$R_{\theta JC(bot)}$ Junction-to-case (bottom) thermal resistance	N/A	4.4	

- (1) For more information about traditional and new thermal metrics, see the *IC Package Thermal Metrics* application report (SPRA953).
- (2) 4 layer board with Cu finished thickness 1.5 oz, 1 oz, 1 oz, 1.5 oz. Maximum die size used. 5x body length of Cu trace on PCB top. 50 x 50 mm ground and power planes embedded in PCB. See Application Note AN-1187 *Leadless Leadframe Package (LLP)* (SNOA401).

6.5 Electrical Characteristics

Specifications in standard typeface are for $T_J = +25^\circ\text{C}$. Unless otherwise specified, $V_{DD} = V_{HB} = 12\text{ V}$, $V_{SS} = V_{HS} = 0\text{ V}$, $RT1 = RT2 = 100\text{ k}\Omega$. No load on LO or HO.

PARAMETER		TEST CONDITIONS	MIN ⁽¹⁾	TYP	MAX ⁽¹⁾	UNIT
SUPPLY CURRENTS						
I_{DD}	V_{DD} Quiescent Current	LI = HI = 0 V		0.4		mA
		LI = HI = 0 V, -40°C to $+125^\circ\text{C}$			0.6	
I_{DDO}	V_{DD} Operating Current	f = 500 kHz		1.5		mA
		f = 500 kHz, -40°C to $+125^\circ\text{C}$			3	
I_{HB}	Total HB Quiescent Current	LI = HI = 0 V		0.06		mA
		LI = HI = 0 V, -40°C to $+125^\circ\text{C}$			0.2	
I_{HBO}	Total HB Operating Current	f = 500 kHz		1.3		mA
		f = 500 kHz, -40°C to $+125^\circ\text{C}$			3	
I_{HBS}	HB to V_{SS} Current, Quiescent	$V_{HS} = V_{HB} = 100\text{ V}$		0.05		μA
		$V_{HS} = V_{HB} = 100\text{ V}$, -40°C to $+125^\circ\text{C}$			10	
I_{HBSO}	HB to V_{SS} Current, Operating	f = 500 kHz		0.08		mA
INPUT PINS						
V_{IL}	Low Level Input Voltage Threshold			1.8		V
		-40°C to $+125^\circ\text{C}$	0.8			
V_{IH}	High Level Input Voltage Threshold			1.8		V
		-40°C to $+125^\circ\text{C}$			2.2	
R_I	Input Pulldown Resistance			200		k Ω
		-40°C to $+125^\circ\text{C}$	100		500	
TIME DELAY CONTROLS						
V_{RT}	Nominal Voltage at RT1, RT2			3		V
		-40°C to $+125^\circ\text{C}$	2.7		3.3	
I_{RT}	RT Pin Current Limit	RT1 = RT2 = 0 V		1.5		mA
		RT1 = RT2 = 0 V, -40°C to $+125^\circ\text{C}$	0.75		2.25	
V_{th}	Timer Termination Threshold			1.8		V
T_{DL1}, T_{DH1}	Rising edge turn-on delay, RT = 10 k Ω			105		ns
		-40°C to $+125^\circ\text{C}$	75		150	
T_{DL2}, T_{DH2}	Rising edge turn-on delay, RT = 100 k Ω			630		ns
		-40°C to $+125^\circ\text{C}$	530		750	
UNDER VOLTAGE PROTECTION						
V_{DDR}	V_{DD} Rising Threshold			6.9		V
		-40°C to $+125^\circ\text{C}$	6.0		7.4	
V_{DDH}	V_{DD} Threshold Hysteresis			0.5		V
V_{HBR}	HB Rising Threshold			6.6		V
		-40°C to $+125^\circ\text{C}$	5.7		7.1	
V_{HBH}	HB Threshold Hysteresis			0.4		V
BOOTSTRAP DIODE						
V_{DL}	Low-Current Forward Voltage	$I_{VDD-HB} = 100\text{ }\mu\text{A}$		0.60		V
		$I_{VDD-HB} = 100\text{ }\mu\text{A}$, -40°C to $+125^\circ\text{C}$			0.9	
V_{DH}	High-Current Forward Voltage	$I_{VDD-HB} = 100\text{ mA}$		0.85		V
		$I_{VDD-HB} = 100\text{ mA}$, -40°C to $+125^\circ\text{C}$			1.1	

(1) MIN and MAX limits are 100% production tested at 25°C . Limits over the operating temperature range are specified through correlation using Statistical Quality Control (SQC) methods. Limits are used to calculate TI's Average Outgoing Quality Level (AOQL).

Electrical Characteristics (continued)

Specifications in standard typeface are for $T_J = +25^\circ\text{C}$. Unless otherwise specified, $V_{DD} = V_{HB} = 12\text{ V}$, $V_{SS} = V_{HS} = 0\text{ V}$, $RT1 = RT2 = 100\text{ k}\Omega$. No load on LO or HO.

PARAMETER	TEST CONDITIONS	MIN ⁽¹⁾	TYP	MAX ⁽¹⁾	UNIT
R_D Dynamic Resistance	$I_{VDD-HB} = 100\text{ mA}$		0.8		Ω
	$I_{VDD-HB} = 100\text{ mA}$, -40°C to $+125^\circ\text{C}$			1.5	
LO GATE DRIVER					
V_{OLL} Low-Level Output Voltage	$I_{LO} = 100\text{ mA}$		0.25		V
	$I_{LO} = 100\text{ mA}$, -40°C to $+125^\circ\text{C}$			0.4	
V_{OHL} High-Level Output Voltage	$I_{LO} = -100\text{ mA}$, $V_{OHL} = V_{DD} - V_{LO}$		0.35		V
	$I_{LO} = -100\text{ mA}$, $V_{OHL} = V_{DD} - V_{LO}$, -40°C to $+125^\circ\text{C}$			0.55	
I_{OHL} Peak Pullup Current	$V_{LO} = 0\text{ V}$		1.6		A
I_{OLL} Peak Pulldown Current	$V_{LO} = 12\text{ V}$		1.8		A
HO GATE DRIVER					
V_{OLH} Low-Level Output Voltage	$I_{HO} = 100\text{ mA}$		0.25		V
	$I_{HO} = 100\text{ mA}$, -40°C to $+125^\circ\text{C}$			0.4	
V_{OHH} High-Level Output Voltage	$I_{HO} = -100\text{ mA}$, $V_{OHH} = V_{HB} - V_{HO}$		0.35		V
	$I_{HO} = -100\text{ mA}$, $V_{OHH} = V_{HB} - V_{HO}$, -40°C to $+125^\circ\text{C}$			0.55	
I_{OHH} Peak Pullup Current	$V_{HO} = 0\text{ V}$		1.6		A
I_{OLH} Peak Pulldown Current	$V_{HO} = 12\text{ V}$		1.8		A

6.6 Switching Characteristics

Specifications in standard typeface are for $T_J = +25^\circ\text{C}$. Unless otherwise specified, $V_{DD} = V_{HB} = 12\text{ V}$, $V_{SS} = V_{HS} = 0\text{ V}$, No Load on LO or HO.

PARAMETER	TEST CONDITIONS	MIN ⁽¹⁾	TYP	MAX ⁽¹⁾	UNIT
t_{LPHL} Lower Turn-Off Propagation Delay LM5102 (LI Falling to LO Falling)			27		ns
	-40°C to $+125^\circ\text{C}$			56	
t_{HPHL} Upper Turn-Off Propagation Delay LM5102 (HI Falling to HO Falling)			27		ns
	-40°C to $+125^\circ\text{C}$			56	
t_{RC} , t_{FC} Either Output Rise/Fall Time	$C_L = 1000\text{ pF}$		15		ns
t_R , t_F Either Output Rise/Fall Time (3 V to 9 V)	$C_L = 0.1\text{ }\mu\text{F}$		0.6		μs
t_{BS} Bootstrap Diode Turn-Off Time	$I_F = 20\text{ mA}$, $I_R = 200\text{ mA}$		50		ns

(1) MIN and MAX limits are 100% production tested at 25°C . Limits over the operating temperature range are specified through correlation using Statistical Quality Control (SQC) methods. Limits are used to calculate TI's Average Outgoing Quality Level (AOQL).

6.7 Typical Characteristics

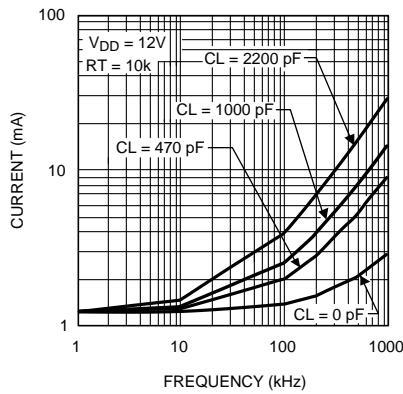

Figure 1. I_{DD} vs Frequency

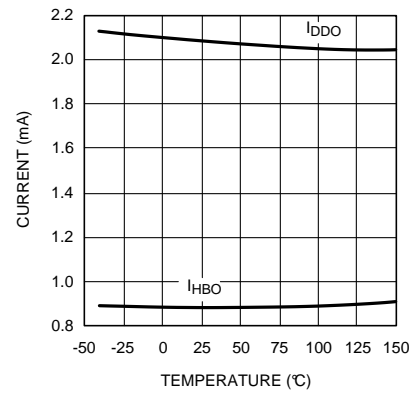

Figure 2. Operating Current vs Temperature

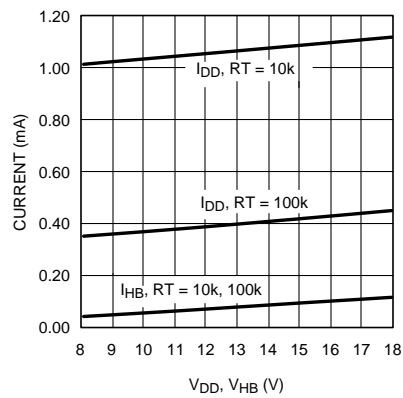

Figure 3. Quiescent Current vs Supply Voltage

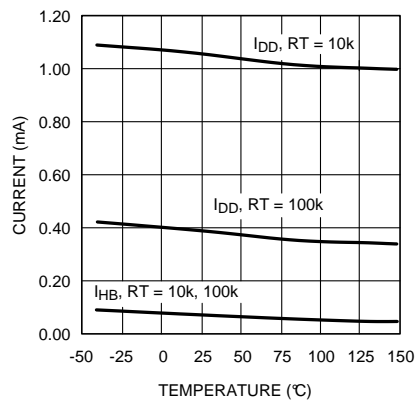

Figure 4. Quiescent Current vs Temperature

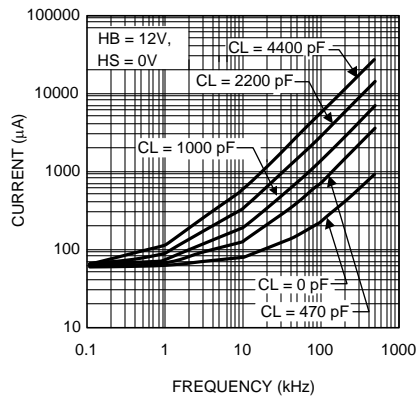

Figure 5. I_{HB} vs Frequency

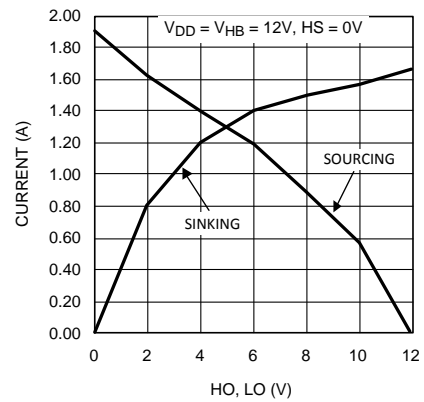

Figure 6. HO and LO Peak Output Current vs Output Voltage

Typical Characteristics (continued)

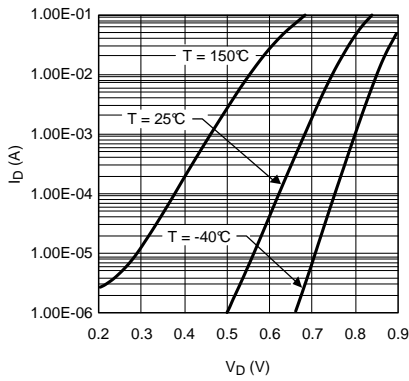

Figure 7. Diode Forward Voltage

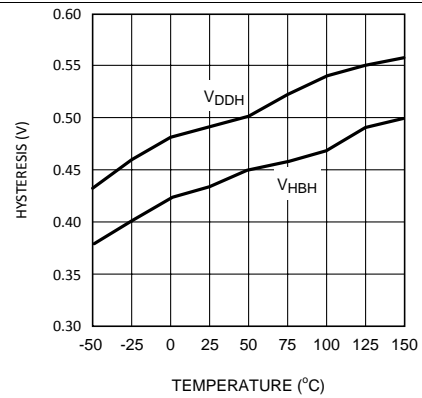

Figure 8. Undervoltage Threshold Hysteresis vs Temperature

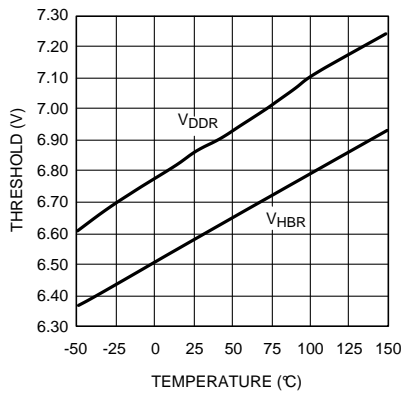

Figure 9. Undervoltage Rising Threshold vs Temperature

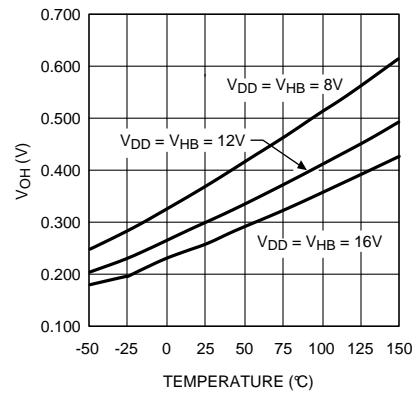

Figure 10. LO and HO Gate Drive — High Level Output Voltage vs Temperature

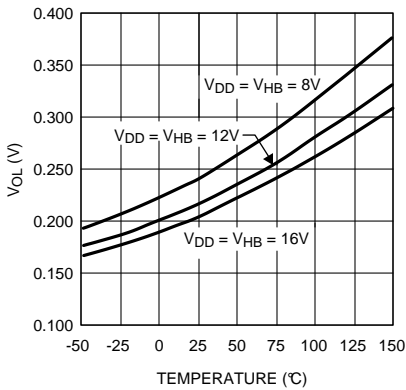

Figure 11. LO and HO Gate Drive — Low Level Output Voltage vs Temperature

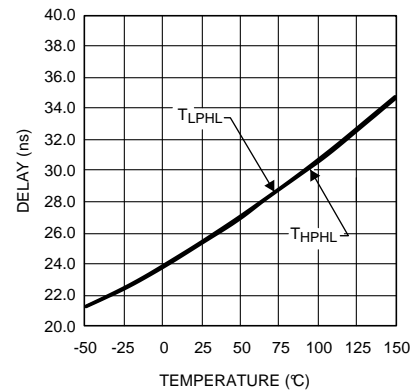

Figure 12. Turn Off Propagation Delay vs Temperature

Typical Characteristics (continued)

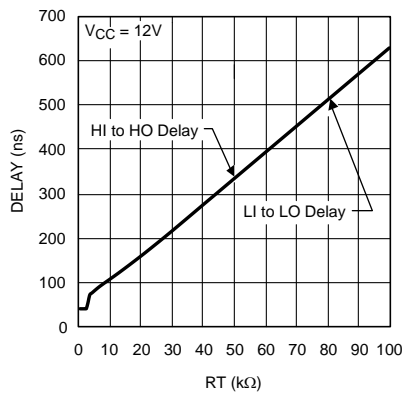

Figure 13. Turn On Delay vs RT Resistor Value

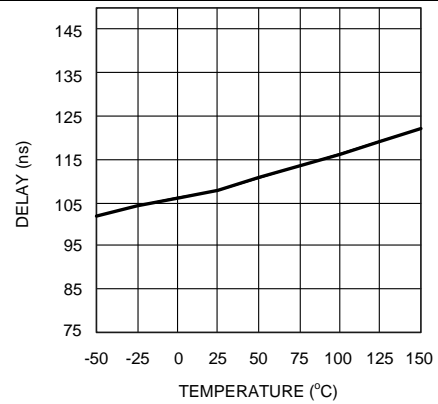

Figure 14. Turn On Delay vs Temperature (RT = 10 k)

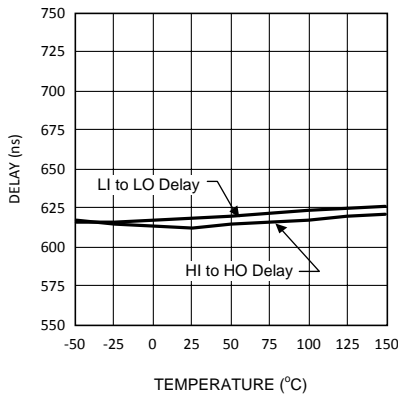

Figure 15. Turn On Delay vs Temperature (RT = 100 k)

7 Detailed Description

7.1 Overview

The LM5102 device offers a unique flexibility with independently programmable delay of the rising edge for both high and low side driver outputs independently. The delays are set with resistors at the RT1 and RT2 pins, and can be adjusted from 100 ns to 600 ns. This feature reduces component count, board space and cost compared to discrete solutions for adjusting driver dead time. The wide delay programming range provides the flexibility to optimize drive signal timing for a wide range of MOSFETs and applications.

The RT pins are biased at 3 V and current limited to 1 mA maximum programming current. The time delay generator will accommodate resistor values from 5 k to 100 k with turn-on delay times that are proportional to the RT resistance. In addition, each RT pin is monitored by a comparator that will bypass the turn-on delay if the RT pin is pulled below the timer elimination threshold (1.8 V typical). Grounding the RT pins programs the LM5102 to drive both outputs with minimum turn-on delay.

7.2 Functional Block Diagram

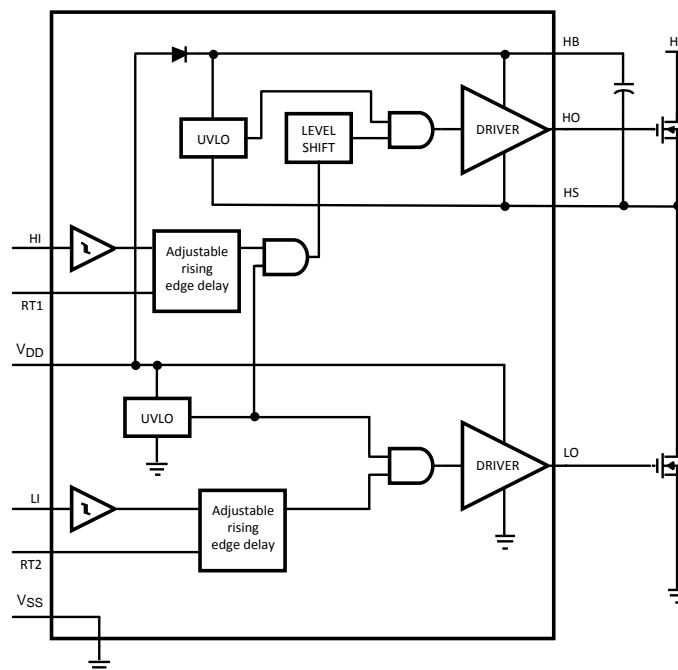

7.3 Feature Description

7.3.1 Startup and UVLO

Both top and bottom drivers include undervoltage lockout (UVLO) protection circuitry which monitors the supply voltage (V_{DD}) and bootstrap capacitor voltage ($V_{HB} - V_{HS}$) independently. The UVLO circuit inhibits each driver until sufficient supply voltage is available to turn-on the external MOSFETs, and the built-in hysteresis prevents chattering during supply voltage transitions. When the supply voltage is applied to V_{DD} pin of LM5102, the top and bottom gates are held low until V_{DD} exceeds UVLO threshold, typically about 6.9 V. Any UVLO condition on the bootstrap capacitor will disable only the high side output (HO).

7.4 Device Functional Modes

LI Pin	LO Pin	HI Pin	HO Pin
L	L	L	L
H	H	H	H

8 Application and Implementation

NOTE

Information in the following applications sections is not part of the TI component specification, and TI does not warrant its accuracy or completeness. TI's customers are responsible for determining suitability of components for their purposes. Customers should validate and test their design implementation to confirm system functionality.

8.1 Application Information

The LM5102 is one of the latest generation of high voltage gate drivers which are designed to drive both the high-side and low-side N-Channel MOSFETs in a half-bridge/full bridge configuration or in a synchronous buck circuit. The floating high side driver is capable of operating with supply voltages up to 100 V. This allows for N-Channel MOSFET control in half-bridge, full-bridge, push-pull, two switch forward and active clamp topologies.

In the LM5102 the outputs are independently controlled. The rising edge of each output can be independently delayed with a programming resistor.

Table 1. LM5102 Highlights

FEATURE	BENEFIT
Independently programmable high and low side delay	Allows optimisation of gate drive timings to account for device differences between high-side and low-side positions
Low power consumption	Improves light load efficiency figures
Internal bootstrap diode	Reduces parts count and PCB real estate

8.2 Typical Application

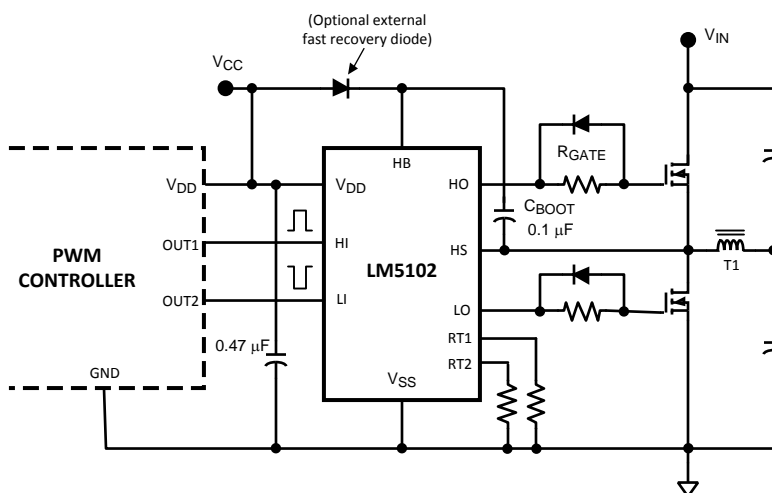

Figure 16. LM5102 Driving MOSFETs Connected in Half-Bridge Configuration

Typical Application (continued)

8.2.1 Design Requirements

PARAMETERS	VALUES
Gate Drive IC	LM5102
Mosfet	CSD18531Q5A
V_{DD}	10 V
Q_{gmax}	43 nC
F_{sw}	100 kHz
D_{Max}	95%
I_{HBO}	10 μ A
V_{DH}	1.1 V
V_{HBR}	7.1 V
V_{HBH}	0.4 V

8.2.2 Detailed Design Procedure

$$\Delta V_{HB} = V_{DD} - V_{DH} - V_{HBL}$$

where

- V_{DD} = Supply voltage of the gate drive IC
- V_{DH} = Bootstrap diode forward voltage drop
- V_{gsmin} = Minimum gate source threshold voltage

$$C_{BOOT} = \frac{Q_{TOTAL}}{\Delta V_{HB}} \quad (1)$$

$$Q_{TOTAL} = Q_{gmax} + I_{HBO} \times \frac{D_{Max}}{F_{SW}} \quad (2)$$

The quiescent current of the bootstrap circuit is 10 μ A which is negligible compared to the Qgs of the mosfet.

$$Q_{TOTAL} = 43nC + 10\mu A \times \frac{0.95}{100kHz} \quad (3)$$

$$Q_{TOTAL} = 43.01 \text{ nC} \quad (4)$$

In practice the value for the C_{BOOT} capacitor should be greater than that calculated to allow for situations where the power stage may skip pulse due to load transients. In this circumstance the boot capacitor must maintain the HB Pin voltage above the UVLO Voltage for the HB circuit.

As a general rule the local V_{DD} bypass capacitor should be 10 times greater than the value of C_{BOOT} .

$$V_{HBL} = V_{HBR} - V_{HBH} \quad (5)$$

$$V_{HBL} = 6.7 \text{ V} \quad (6)$$

$$\Delta V_{HB} = 10 \text{ V} - 1.1 \text{ V} - 6.7 \text{ V} \quad (7)$$

$$\Delta V_{HB} = 2.2 \text{ V} \quad (8)$$

$$C_{BOOT} = \frac{43.01nC}{2.2V} \quad (9)$$

$$C_{BOOT} = 19.54 \text{ nF} \quad (10)$$

The bootstrap and bias capacitors should be ceramic types with X7R dielectric. The voltage rating should be twice that of the maximum VDD to allow for loss of capacitance once the devices have a dc bias voltage across them and to ensure long term reliability of the devices.

The resistor values, RT1 and RT2, for setting turn on delay can be found in [Figure 18](#).

8.2.3 Application Curves

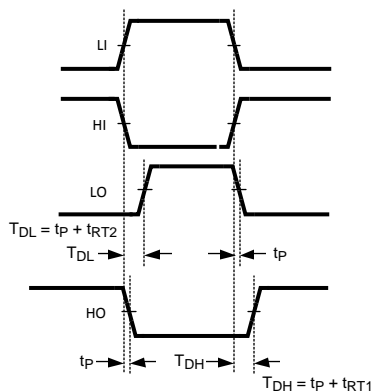

Figure 17. Application Timing Waveforms

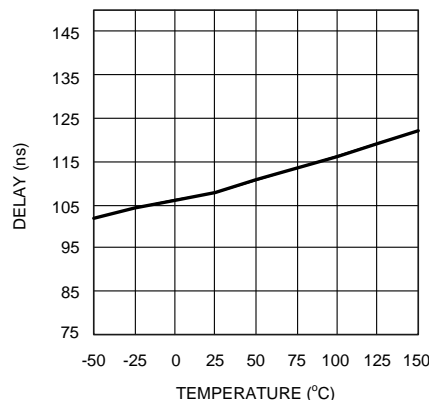

Figure 18. Turn On Delay vs Temperature (RT = 10 k)

9 Power Supply Recommendations

9.1 Power Dissipation Considerations

The total IC power dissipation is the sum of the gate driver losses and the bootstrap diode losses. The gate driver losses are related to the switching frequency (f), output load capacitance on LO and HO (C_L), and supply voltage (V_{DD}) and can be roughly calculated as shown in Equation 12.

$$P_{DGATES} = 2 \times f \times C_L \times V_{DD}^2 \quad (12)$$

There are some additional losses in the gate drivers due to the internal CMOS stages used to buffer the LO and HO outputs. The following plot shows the measured gate driver power dissipation versus frequency and load capacitance. At higher frequencies and load capacitance values, the power dissipation is dominated by the power losses driving the output loads and agrees well with the above equation. This plot can be used to approximate the power losses due to the gate drivers.

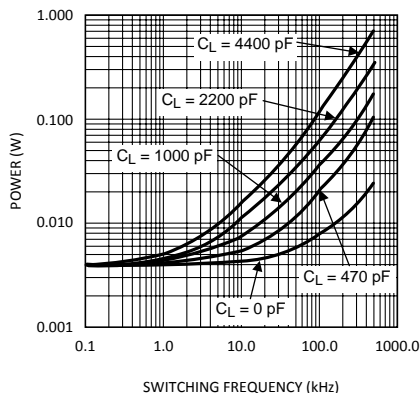

Figure 19. Gate Driver Power Dissipation (LO + HO)
 $V_{CC} = 12 \text{ V}$, Neglecting Diode Losses

The bootstrap diode power loss is the sum of the forward bias power loss that occurs while charging the bootstrap capacitor and the reverse bias power loss that occurs during reverse recovery. Because each of these events happens once per cycle, the diode power loss is proportional to frequency. Larger capacitive loads require more current to recharge the bootstrap capacitor resulting in more losses. Higher input voltages (V_{IN}) to the half bridge result in higher reverse recovery losses. Figure 20 was generated based on calculations and lab measurements of the diode recovery time and current under several operating conditions. This can be useful for approximating the diode power dissipation.

Power Dissipation Considerations (continued)

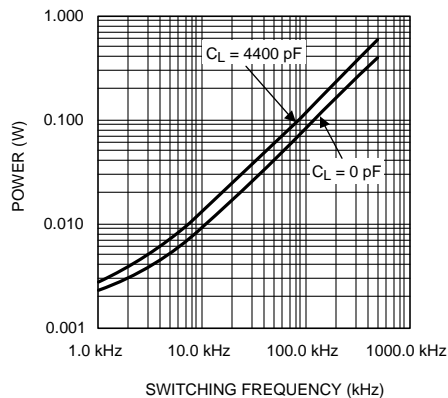

Figure 20. Diode Power Dissipation $V_{IN} = 80\text{ V}$

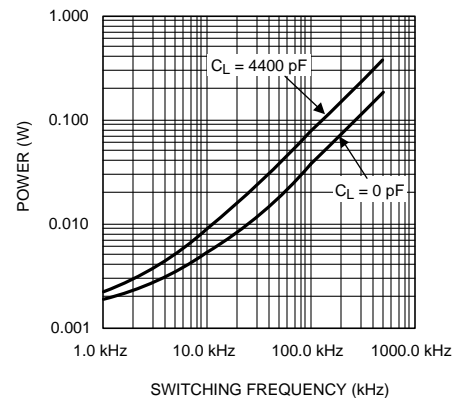

Figure 21. Diode Power Dissipation $V_{IN} = 40\text{ V}$

The total IC power dissipation can be estimated from the above plots by summing the gate drive losses with the bootstrap diode losses for the intended application. Because the diode losses can be significant, an external diode placed in parallel with the internal bootstrap diode (refer to [Figure 16](#)) and can be helpful in removing power from the IC. For this to be effective, the external diode must be placed close to the IC to minimize series inductance and have a significantly lower forward voltage drop than the internal diode.

10 Layout

10.1 Layout Guidelines

The optimum performance of high and low side gate drivers cannot be achieved without taking due considerations during circuit board layout. Following points are emphasized.

1. A low ESR/ESL capacitor must be connected close to the IC, and between V_{DD} and V_{SS} pins and between HB and HS pins to support high peak currents being drawn from V_{DD} during turn-on of the external MOSFET.
2. To prevent large voltage transients at the drain of the top MOSFET, a low ESR electrolytic capacitor must be connected between MOSFET drain and ground (V_{SS}).
3. In order to avoid large negative transients on the switch node (HS) pin, the parasitic inductances in the source of top MOSFET and in the drain of the bottom MOSFET (synchronous rectifier) must be minimized.
4. Grounding considerations:
 - The first priority in designing grounding connections is to confine the high peak currents from charging and discharging the MOSFET gate in a minimal physical area. This will decrease the loop inductance and minimize noise issues on the gate terminal of the MOSFET. The MOSFETs should be placed as close as possible to the gate driver.
 - The second high current path includes the bootstrap capacitor, the bootstrap diode, the local ground referenced bypass capacitor and low side MOSFET body diode. The bootstrap capacitor is recharged on the cycle-by-cycle basis through the bootstrap diode from the ground referenced V_{DD} bypass capacitor. The recharging occurs in a short time interval and involves high peak current. Minimizing this loop length and area on the circuit board is important to ensure reliable operation.
5. The resistors on the RT1 and RT2 timer pins must be placed very close to the IC and separated from high current paths to avoid noise coupling to the time delay generator which could disrupt timer operation.

10.2 Layout Example

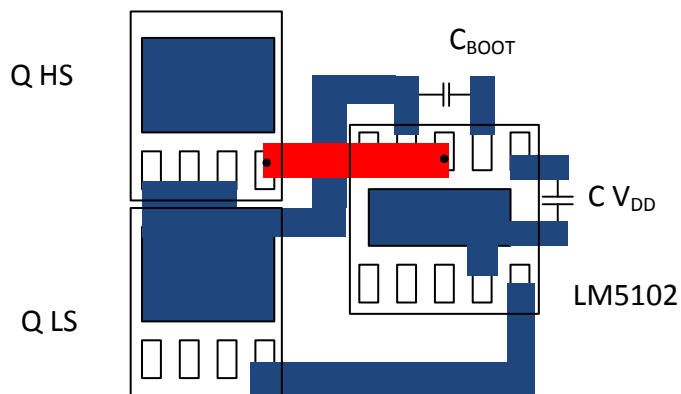

Figure 22. LM5102 Component Placement

11 Device and Documentation Support

11.1 Trademarks

All trademarks are the property of their respective owners.

11.2 Electrostatic Discharge Caution



These devices have limited built-in ESD protection. The leads should be shorted together or the device placed in conductive foam during storage or handling to prevent electrostatic damage to the MOS gates.

11.3 Glossary

[SLYZ022](#) — *TI Glossary*.

This glossary lists and explains terms, acronyms, and definitions.

12 Mechanical, Packaging, and Orderable Information

The following pages include mechanical, packaging, and orderable information. This information is the most current data available for the designated devices. This data is subject to change without notice and revision of this document. For browser-based versions of this data sheet, refer to the left-hand navigation.

PACKAGING INFORMATION

Orderable part number	Status (1)	Material type (2)	Package Pins	Package qty Carrier	RoHS (3)	Lead finish/ Ball material (4)	MSL rating/ Peak reflow (5)	Op temp (°C)	Part marking (6)
LM5102MM/NOPB	Active	Production	VSSOP (DGS) 10	1000 SMALL T&R	Yes	SN	Level-1-260C-UNLIM	-40 to 125	5102
LM5102MM/NOPB.A	Active	Production	VSSOP (DGS) 10	1000 SMALL T&R	Yes	SN	Level-1-260C-UNLIM	-40 to 125	5102
LM5102MM/NOPB.B	Active	Production	VSSOP (DGS) 10	1000 SMALL T&R	Yes	SN	Level-1-260C-UNLIM	-40 to 125	5102
LM5102MMX/NOPB	Active	Production	VSSOP (DGS) 10	3500 LARGE T&R	Yes	SN	Level-1-260C-UNLIM	-40 to 125	5102
LM5102MMX/NOPB.A	Active	Production	VSSOP (DGS) 10	3500 LARGE T&R	Yes	SN	Level-1-260C-UNLIM	-40 to 125	5102
LM5102MMX/NOPB.B	Active	Production	VSSOP (DGS) 10	3500 LARGE T&R	Yes	SN	Level-1-260C-UNLIM	-40 to 125	5102
LM5102SD/NOPB	Active	Production	WSON (DPR) 10	1000 SMALL T&R	Yes	SN	Level-1-260C-UNLIM	-40 to 125	5102SD
LM5102SD/NOPB.A	Active	Production	WSON (DPR) 10	1000 SMALL T&R	Yes	SN	Level-1-260C-UNLIM	-40 to 125	5102SD
LM5102SD/NOPB.B	Active	Production	WSON (DPR) 10	1000 SMALL T&R	Yes	SN	Level-1-260C-UNLIM	-40 to 125	5102SD
LM5102SDX/NOPB	Active	Production	WSON (DPR) 10	4500 LARGE T&R	Yes	SN	Level-1-260C-UNLIM	-40 to 125	5102SD
LM5102SDX/NOPB.A	Active	Production	WSON (DPR) 10	4500 LARGE T&R	Yes	SN	Level-1-260C-UNLIM	-40 to 125	5102SD
LM5102SDX/NOPB.B	Active	Production	WSON (DPR) 10	4500 LARGE T&R	Yes	SN	Level-1-260C-UNLIM	-40 to 125	5102SD

(1) **Status:** For more details on status, see our [product life cycle](#).

(2) **Material type:** When designated, preproduction parts are prototypes/experimental devices, and are not yet approved or released for full production. Testing and final process, including without limitation quality assurance, reliability performance testing, and/or process qualification, may not yet be complete, and this item is subject to further changes or possible discontinuation. If available for ordering, purchases will be subject to an additional waiver at checkout, and are intended for early internal evaluation purposes only. These items are sold without warranties of any kind.

(3) **RoHS values:** Yes, No, RoHS Exempt. See the [TI RoHS Statement](#) for additional information and value definition.

(4) **Lead finish/Ball material:** Parts may have multiple material finish options. Finish options are separated by a vertical ruled line. Lead finish/Ball material values may wrap to two lines if the finish value exceeds the maximum column width.

(5) **MSL rating/Peak reflow:** The moisture sensitivity level ratings and peak solder (reflow) temperatures. In the event that a part has multiple moisture sensitivity ratings, only the lowest level per JEDEC standards is shown. Refer to the shipping label for the actual reflow temperature that will be used to mount the part to the printed circuit board.

(6) **Part marking:** There may be an additional marking, which relates to the logo, the lot trace code information, or the environmental category of the part.

Multiple part markings will be inside parentheses. Only one part marking contained in parentheses and separated by a "-" will appear on a part. If a line is indented then it is a continuation of the previous line and the two combined represent the entire part marking for that device.

Important Information and Disclaimer: The information provided on this page represents TI's knowledge and belief as of the date that it is provided. TI bases its knowledge and belief on information provided by third parties, and makes no representation or warranty as to the accuracy of such information. Efforts are underway to better integrate information from third parties. TI has taken and continues to take reasonable steps to provide representative and accurate information but may not have conducted destructive testing or chemical analysis on incoming materials and chemicals. TI and TI suppliers consider certain information to be proprietary, and thus CAS numbers and other limited information may not be available for release.

In no event shall TI's liability arising out of such information exceed the total purchase price of the TI part(s) at issue in this document sold by TI to Customer on an annual basis.

TAPE AND REEL INFORMATION

QUADRANT ASSIGNMENTS FOR PIN 1 ORIENTATION IN TAPE

*All dimensions are nominal

Device	Package Type	Package Drawing	Pins	SPQ	Reel Diameter (mm)	Reel Width W1 (mm)	A0 (mm)	B0 (mm)	K0 (mm)	P1 (mm)	W (mm)	Pin1 Quadrant
LM5102MM/NOPB	VSSOP	DGS	10	1000	177.8	12.4	5.3	3.4	1.4	8.0	12.0	Q1
LM5102MMX/NOPB	VSSOP	DGS	10	3500	330.0	12.4	5.3	3.4	1.4	8.0	12.0	Q1
LM5102SD/NOPB	WSO	DPR	10	1000	177.8	12.4	4.3	4.3	1.3	8.0	12.0	Q1
LM5102SDX/NOPB	WSO	DPR	10	4500	330.0	12.4	4.3	4.3	1.3	8.0	12.0	Q1

TAPE AND REEL BOX DIMENSIONS

*All dimensions are nominal

Device	Package Type	Package Drawing	Pins	SPQ	Length (mm)	Width (mm)	Height (mm)
LM5102MM/NOPB	VSSOP	DGS	10	1000	208.0	191.0	35.0
LM5102MMX/NOPB	VSSOP	DGS	10	3500	367.0	367.0	35.0
LM5102SD/NOPB	WSON	DPR	10	1000	208.0	191.0	35.0
LM5102SDX/NOPB	WSON	DPR	10	4500	367.0	367.0	35.0

DGS0010A

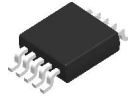

PACKAGE OUTLINE

VSSOP - 1.1 mm max height

SMALL OUTLINE PACKAGE

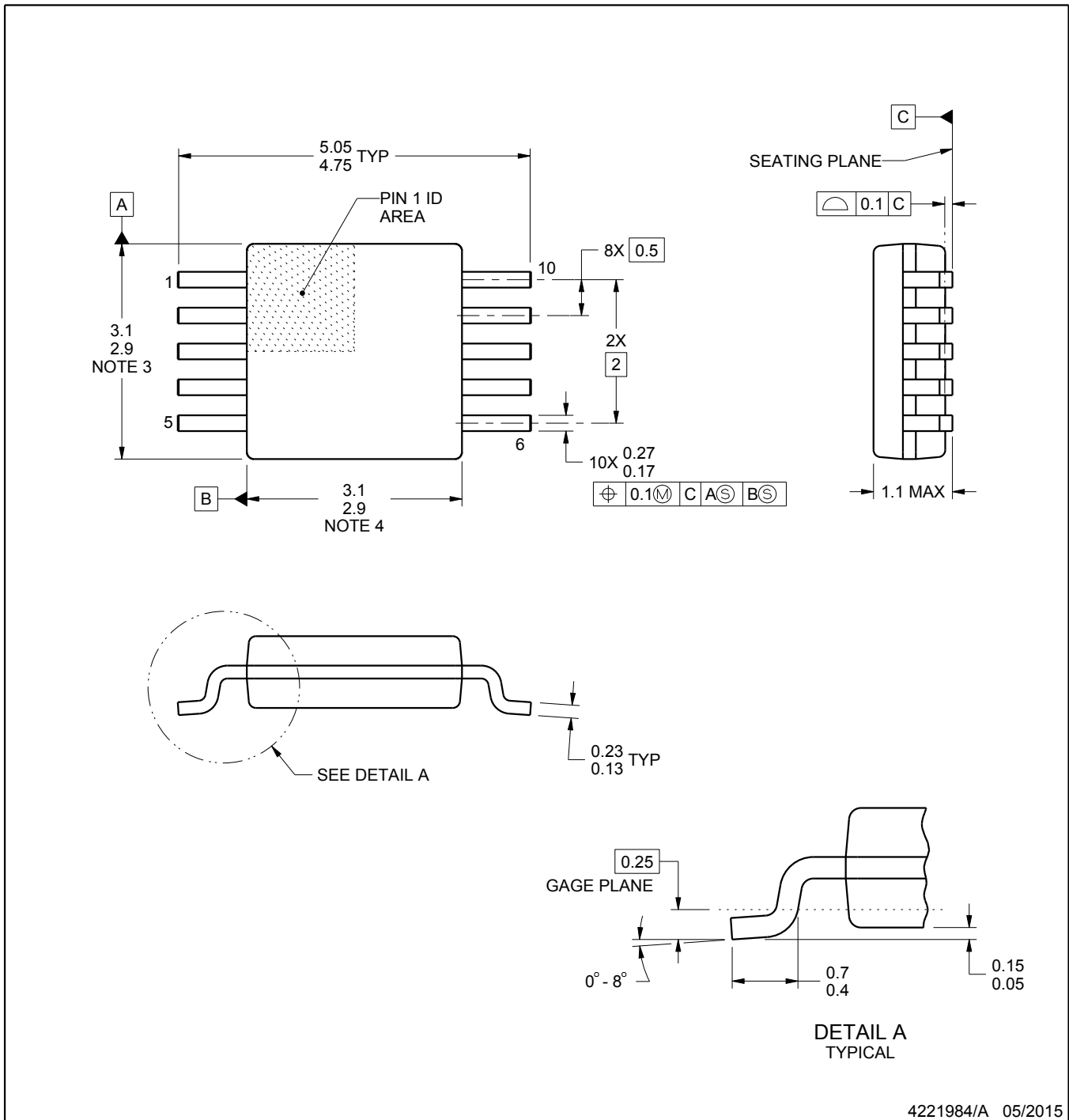

NOTES:

1. All linear dimensions are in millimeters. Any dimensions in parenthesis are for reference only. Dimensioning and tolerancing per ASME Y14.5M.
2. This drawing is subject to change without notice.
3. This dimension does not include mold flash, protrusions, or gate burrs. Mold flash, protrusions, or gate burrs shall not exceed 0.15 mm per side.
4. This dimension does not include interlead flash. Interlead flash shall not exceed 0.25 mm per side.
5. Reference JEDEC registration MO-187, variation BA.

EXAMPLE BOARD LAYOUT

DGS0010A

VSSOP - 1.1 mm max height

SMALL OUTLINE PACKAGE



LAND PATTERN EXAMPLE
SCALE:10X

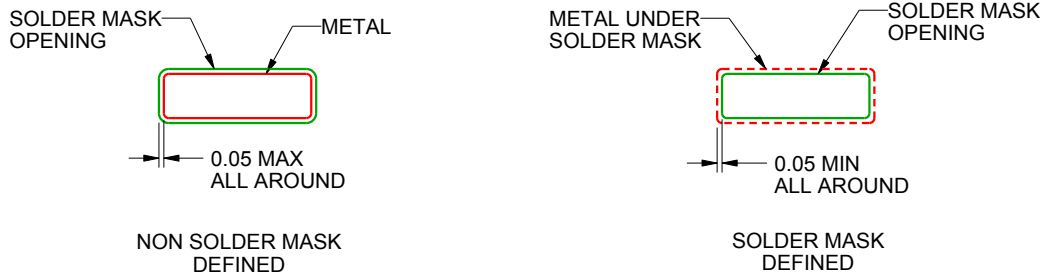

SOLDER MASK DETAILS
NOT TO SCALE

4221984/A 05/2015

NOTES: (continued)

- 6. Publication IPC-7351 may have alternate designs.
- 7. Solder mask tolerances between and around signal pads can vary based on board fabrication site.

EXAMPLE STENCIL DESIGN

DGS0010A

VSSOP - 1.1 mm max height

SMALL OUTLINE PACKAGE



SOLDER PASTE EXAMPLE
BASED ON 0.125 mm THICK STENCIL
SCALE:10X

4221984/A 05/2015

NOTES: (continued)

8. Laser cutting apertures with trapezoidal walls and rounded corners may offer better paste release. IPC-7525 may have alternate design recommendations.
9. Board assembly site may have different recommendations for stencil design.

GENERIC PACKAGE VIEW

DPR 10

WSON - 0.8 mm max height

4 x 4, 0.8 mm pitch

PLASTIC SMALL OUTLINE - NO LEAD

This image is a representation of the package family, actual package may vary.
Refer to the product data sheet for package details.

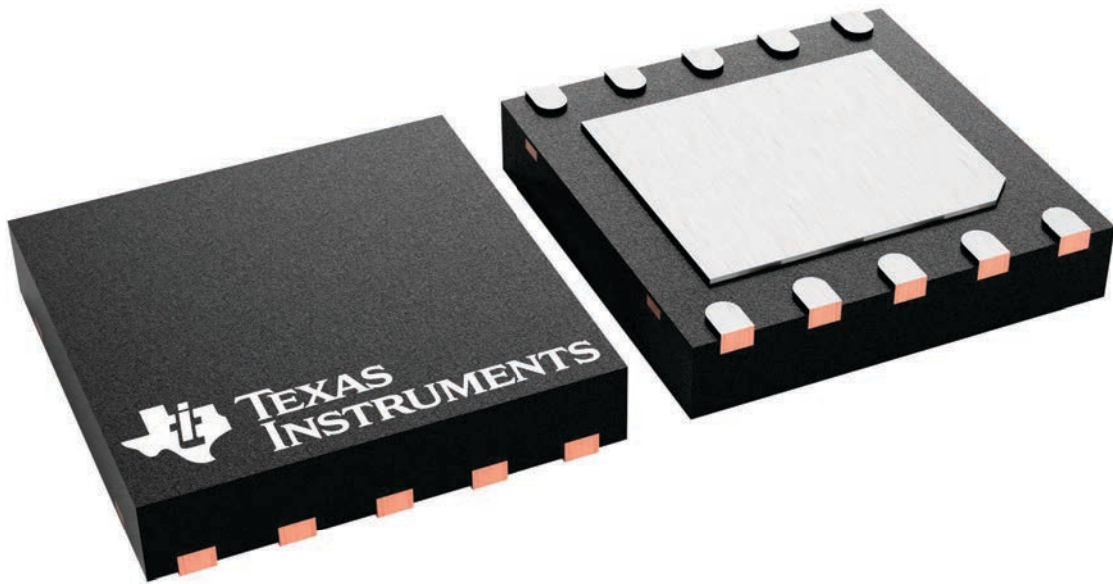

4232220/A

IMPORTANT NOTICE AND DISCLAIMER

TI PROVIDES TECHNICAL AND RELIABILITY DATA (INCLUDING DATASHEETS), DESIGN RESOURCES (INCLUDING REFERENCE DESIGNS), APPLICATION OR OTHER DESIGN ADVICE, WEB TOOLS, SAFETY INFORMATION, AND OTHER RESOURCES "AS IS" AND WITH ALL FAULTS, AND DISCLAIMS ALL WARRANTIES, EXPRESS AND IMPLIED, INCLUDING WITHOUT LIMITATION ANY IMPLIED WARRANTIES OF MERCHANTABILITY, FITNESS FOR A PARTICULAR PURPOSE OR NON-INFRINGEMENT OF THIRD PARTY INTELLECTUAL PROPERTY RIGHTS.

These resources are intended for skilled developers designing with TI products. You are solely responsible for (1) selecting the appropriate TI products for your application, (2) designing, validating and testing your application, and (3) ensuring your application meets applicable standards, and any other safety, security, regulatory or other requirements.

These resources are subject to change without notice. TI grants you permission to use these resources only for development of an application that uses the TI products described in the resource. Other reproduction and display of these resources is prohibited. No license is granted to any other TI intellectual property right or to any third party intellectual property right. TI disclaims responsibility for, and you fully indemnify TI and its representatives against any claims, damages, costs, losses, and liabilities arising out of your use of these resources.

TI's products are provided subject to [TI's Terms of Sale](#), [TI's General Quality Guidelines](#), or other applicable terms available either on ti.com or provided in conjunction with such TI products. TI's provision of these resources does not expand or otherwise alter TI's applicable warranties or warranty disclaimers for TI products. Unless TI explicitly designates a product as custom or customer-specified, TI products are standard, catalog, general purpose devices.

TI objects to and rejects any additional or different terms you may propose.

Copyright © 2025, Texas Instruments Incorporated

Last updated 10/2025